



UNIQUE LIGHTING SYSTEMS 20 05



# UNIQUE LIGHTING SYSTEMS



## TABLE OF CONTENTS

Page 1-18

Brass Fixtures



Page 19

Well Lights

Page 20-23

Copper Fixtures



Page 24-27

*Signature Series*



Page 28-30

Transformers & Hubs

Page 31

Lamps

Page 32

Accessories

Page 33

Architects & Designers



## *Unique Exclusive* What is the Consumer Buyer Protection Plan?

The Consumer Buyer Protection Plan is a simple, yet thoroughly drafted plan for the installer to follow, guaranteeing "Zero Call Backs". The CBPP ensures the integrity of the lighting system.



### *Zero Call Backs*

If an installer uses Unique Lighting Systems products for the complete lighting system (transformer, fixtures and hub), we are able to warranty the system against corrosion, wicking, oxidation and polarity issues.

### *Full Warranty*

Since we are unable to warranty workmanship, the CBPP serves as a check system to ensure your contractor is installing your system correctly. The key is the Verification Forms; the installer must perform three critical functions to ensure Unique Lighting Systems and the client: No overloads, No shorts, 11.5 volts to the lamps, Not to be over-volted, Not to be under-volted, No blown fuses, The perfect installation and Zero call backs.

### *Integrity*

Here's how it works....

Step 1. The installer must fill out the supplied Verification Forms. This means they must check the primary amps on the transformer with an amp probe, make sure there are no more than 16 amps on the secondary side and there are 12 volts to the Satellite Hub.

Step 2. The installer must complete the Lamp Replacement Chart,

Step 3. The installer must complete the As-Built.

### *Lifetime*

When the installer has completed this thorough inspection process, Unique Lighting Systems can warranty the system FOR LIFE.





## The Unique Lighting Power Management Hub System



LIFETIME WARRANTY (ON THE ENTIRE SYSTEM)...

Unique is the ONLY manufacturer that will warranty the fixtures, the wire connections, and the transformer, essentially the entire system, for life! This one of a kind lifetime warranty protects homeowners not only against rust and corrosion of the fixtures, but also the sockets, all related hardware, wire connections and the solid brass construction. Working harder and smarter, we continue to manufacture the most innovative and longest lasting landscape lighting products.

### Step 1

Home run #12/2 wire

#### The Multimatic Power Transformer

- Independent voltage taps (ranging from 12 to 22 volts)
- Compensates for voltage drop from transformer to hub
- Delivers proper voltage to each hub with the ability to have multiple hubs



Satellite Hub

### Step 2

#### The Satellite Hub

Pulsar

Distributes proper voltage evenly to every lamp

Eliminates wire connections below ground

Secondary fusing at the hub allows fuse sizing according to load or wire size

Makes installation easier and more consistent with fewer problems

Big Bang



Starburst

### Step 3

#### The Fixtures

- Completes the system
- Pre-wired, 25 or 50 feet, #16-2 wire lead
- Eliminates the need for sealed wire nuts
- All connections are above ground or sealed within the Satellite Hub housing



Constellation



Mercury 7







Model Shown: PULSAR-B25-35-WB



PATENT PENDING



Replaceable Lock & Load Socket

25 foot wire lead included

# PULSAR CAST BRASS MR-16 BULLET UP LIGHT

- Construction: Cast Brass with Aircraft Quality Double Silicon "O" Rings
- Shroud: Lock and Load, 360° Rotation, 8 Settings
- Socket: Replaceable Lock & Load Socket (pre-greased)
- Knuckle: Cast Brass, Adjustable
- Finish Coat: Poly-Thermal Shield
- Wire: 25 Feet, 16/2 THW UV Brown
- Stake: Brown PVC Gravity Stake
- Weight: 2.3 lbs.
- Level of Light Application: 1, 2 & 3
- Lamp: 35 Watt MR-16 FMW, 4,000 hr. Rating
- Maximum Wattage: 35 Watts
- Lifetime Warranty
- Patented

### LENSES INCLUDED



MR-16



Convex Lens



De-Op Lens (Frosted)



Vi-Op Lens (Spread)



Ax-Op Lens (Linear Spread)



Hex Louver



Retainer Clip



WB Weathered Brass



NB Natural Brass



TT Tucson Tan



WH White



BK Black



VG Verde Green

Custom Colors available upon request. Please inquire about lead times.





Model Shown: PROBE-OBM-B25-35-WB

## PROBE CAST BRASS MR-16 BULLET UP LIGHT

- Construction: Cast Brass with Aircraft Quality Double Silicon "O" Rings
- Socket: Replaceable Lock & Load Socket (pre-greased)
- Knuckle: Ball and Joint, 360° Orbital Mount
- Finish Coat: Poly-Thermal Shield
- Stake: Brown PVC Gravity Stake
- Shroud: Lock and Load, 360° Rotation
- Weight: 1.7 lbs.
- Wire: 25 Feet, 16/2 THW UV Brown
- Level of Light Application: 1, 2 & 3
- Lamp: 35 Watt MR-16 FMW, 4,000 hr. Rating
- Maximum Wattage: 35 Watts
- Lifetime Warranty**

**PATENT PENDING**

360° Rotatable Orbital Mount



**PATENT PENDING**



Replaceable Lock & Load Socket

25 foot wire lead included

\* Side Mount Option Available For Down Lighting



### LENSES INCLUDED



MR-16



Convex Lens



De-Op Lens (Frosted)



Vi-Op Lens (Spread)



Ax-Op Lens (Linear Spread)



Hex Louver



Retainer Clip



WB Weathered Brass



NB Natural Brass



TT Tucson Tan



WH White



BK Black



VG Verde Green

Custom Colors available upon request. Please inquire about lead times.





Model Shown: BIGBANG-B25-35-WB

# BIG BANG CAST BRASS PAR 36 DIRECTIONAL UP LIGHT



- Construction: Cast Brass
- Knuckle: Cast Brass, Adjustable
- Shroud: Lock and Load, 360° Rotation
- Finish Coat: Poly-Thermal Shield
- Stake: Brown PVC Stabilizer Stake
- Weight: 4.67 lbs.
- Wire: 25 Feet, 16/2 THW UV Brown
- Level of Light Application: 1, 2 & 3
- Lamp: 35 Watt PAR 36 WF Halogen, 4,000 hr. Rating
- Maximum Wattage: 50 Watts
- Lifetime Warranty**

**PATENT PENDING**



Rubber Gasket  
Lens Holder

25 foot wire lead included

### LENSES INCLUDED

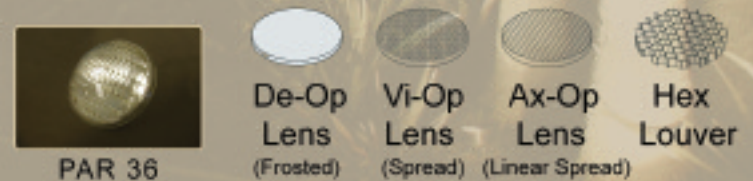

Custom Colors available upon request. Please inquire about lead times.



Model Shown: STARBURST-B25-35-WB  
(Shown with front mounted MR-16 FMW)

# STARBURST CAST BRASS DIRECTIONAL WALL WASHER



**PATENT PENDING**



Rubber Gasket  
Lens Holder

**PATENT PENDING**



Replaceable  
Lock & Load Socket

25 foot wire lead included

- Construction: Cast Brass
- Socket: Replaceable Lock & Load with DUAL Lock & Load Function. Front mount MR-16 or Side Mount Astro-Brite (pre-greased)
- Knuckle: Cast Brass Adjustable
- Finish Coat: Poly-Thermal Shield
- Stake: Brown PVC Stabilizer Stake
- Weight: 4.1 lbs.
- Wire: 25 Feet, 16/2 THW UV Brown
- Level of Light Application: 1, 2 & 3
- Lamp: 35 Watt MR-16 FMW, 4,000 hr. Rating or 35 Watt Astro-Brite, 5,000 hr. Rating. (Both Included)
- Maximum Wattage: 35 Watts
- **Lifetime Warranty**

### LENSES INCLUDED



MR-16

Both  
Included



Astro-Brite

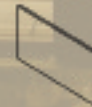

Clear



De-Op  
Lens  
(Frosted)



Vi-Op  
Lens  
(Spread)



Ax-Op  
Lens  
(Linear Spread)



WB  
Weathered Brass



NB  
Natural Brass



TT  
Tucson Tan



WH  
White



BK  
Black



VG  
Verde Green

Custom Colors available upon request. Please inquire about lead times.





Model Shown: STELLAR-B25-20-WB



PATENT PENDING

Rubber Gasket  
Lens Holder

25 foot wire lead included

# STELLAR CAST BRASS MINI WALL WASHER

- Construction: Cast Brass
- Socket: Stainless Steel (pre-greased)
- Knuckle: Cast Brass Adjustable
- Finish Coat: Poly-Thermal Shield
- Stake: Brown PVC Gravity Stake
- Weight: 1.2 lbs.
- Wire: 25 Feet, 16/2 THW UV Brown
- Level of Light Application: 1, 2 & 3
- Lamp: 20 Watt Astro-Brite, 10,000 hr. Rating
- Maximum Wattage: 20 Watts
- Lifetime Warranty**

### LENSES INCLUDED



Astro-Brite



Clear

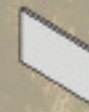

De-Op  
Lens  
(Frosted)



Vi-Op  
Lens  
(Spread)



Ax-Op  
Lens  
(Linear Spread)



WB  
Weathered Brass



NB  
Natural Brass



TT  
Tucson Tan



WH  
White



BK  
Black



VG  
Verde Green

Custom Colors available upon request. Please inquire about lead times.



# APOLLO WELL LIGHT

Model Shown: APOLLO-B25-35-BK

• Shown with optional commercial grade brass grate.

← 5.5" →



8.0"

**PATENTED**



Adjustable  
Stainless Steel  
Gimble Ring

- Construction: ABS Composite & Brass
- Housing: ABS Composite
- Debris Guard: Brass Ring with Clear Glass
- Weight: 1.95 lbs.
- Wire: 25 Feet, 16/2 THW UV Brown
- Level of Light Application: 1, 2 & 3
- Lamp: 35 Watt PAR 36, 4,000 hr. Rating
- Maximum Wattage: 50 Watts
- **Lifetime Warranty**

25 foot wire lead included

## LENSES INCLUDED



Optional Eclipse Glare Shield Available.



Brass Debris Guard Comes Standard.



PAR 36



De-Op  
Lens  
(Frosted)



Vi-Op  
Lens  
(Spread)



Ax-Op  
Lens  
(Linear Spread)



Hex  
Louver



BK  
Black Housing



WB  
Weathered Brass Debris Guard



ABS Grate Included.





# NOVA CAST BRASS MR-16 WELL LIGHT

Model shown: NOVA-B25-20-WB



25 foot wire lead included



Cast Brass Shroud Included

- Construction: Cast Brass
- Socket: Stainless Steel (pre-greased)
- Finish Coat: Poly-Thermal Shield
- Shroud: Cast Brass, Included
- Weight: 1.55 lbs.
- Wire: 25 Feet, 16/2 THW UV Brown
- Level of Light Application: 1, 2 & 3
- Lamp: 20 Watt MR-16 BAB, 4,000 hr. Rating
- Maximum Wattage: 20 Watts
- **Lifetime Warranty**

### LENSES INCLUDED



MR-16



De-Op Lens  
(Frosted)



Vi-Op Lens  
(Spread)



Ax-Op Lens  
(Linear Spread)



Hex Louver



Domed De-Op



WB Weathered Brass



NB Natural Brass



TT Tucson Tan



WH White



BK Black



VG Verde Green

Custom Colors available upon request. Please inquire about lead times.



Model Shown: LUNAR-B25-35-WB

# LUNAR & QUASAR1 CAST BRASS DOWN LIGHTS

25 foot wire lead included



360° Rotatable Orbital Mount

360° Rotatable Orbital Mount

**PATENT PENDING**



Stratosphere Mounting Bracket



Replaceable Lock & Load Socket

- Construction: Cast Brass with Aircraft Quality Silicon "O" Rings
- Socket: Replaceable Lock & Load Socket (pre-greased)
- Knuckle: Ball & Joint, 360° Orbital Mount
- Mounting: Stratosphere Bracket
- Finish Coat: Poly-Thermal Shield
- Shroud: Lock & Load 360° Rotation, MR-16 Recessed. Lunar, Extra Long to Eliminate Glare
- Weight: Lunar: 2.34 lbs. Quasar1: 1.91 lbs.
- Wire: 25 Feet, 16/2 THW UV Brown
- Level of Light Application: 1, 2 & 3
- Lamp: 35 Watt MR-16 FMW, 4,000 hr. Rating
- Maximum Wattage: 35 Watts
- **Lifetime Warranty**

## LENSES INCLUDED



MR-16



De-Op Lens (Frosted)



Vi-Op Lens (Spread)



Ax-Op Lens (Linear Spread)



Hex Louver



Blue Lens



WB Weathered Brass



NB Natural Brass



TT Tucson Tan



WH White



BK Black



VG Verde Green

Custom Colors available upon request. Please inquire about lead times.





Model Shown: QUASAR2-B25-35-WB

# Quasar 2 BRASS DOWN LIGHT

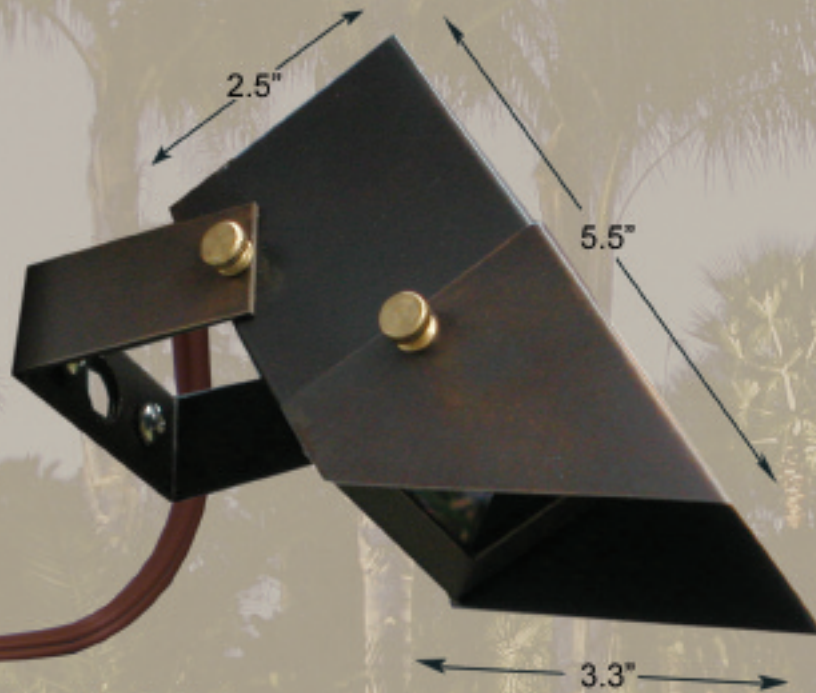

25 foot wire lead included

- Construction: Brass
- Socket: Stainless Steel (pre-greased)
- Knuckle: Brass Locking Adjustment Screws
- Mounting: Surface Mount with J-Box
- Finish Coat: Poly-Thermal Shield
- Shield: Glare Shield Included
- Weight: 1.0 lbs.
- Wire: 25 Feet, 16/2 THW UV Brown, White
- Level of Light Application: 1, 2 & 3
- Lamp: 35 Watt MR-16 FMW, 4,000 hr. Rating
- Maximum Wattage: 35 Watts
- Lifetime Warranty**

### LENSES INCLUDED



MR-16



De-Op Lens (Frosted)



Vi-Op Lens (Spread)



Ax-Op Lens (Linear Spread)



Hex Louver



Blue Lens



Retainer Clip



WB Weathered Brass



NB Natural Brass



TT Tucson Tan



WH White



BK Black



VG Verde Green

Custom Colors available upon request. Please inquire about lead times.





Model Shown: COMET-B25-20-WB

## COMET MINI DOWN LIGHT/HANGING LIGHT



25 foot wire lead included

**PATENT PENDING**

360° Rotatable Orbital Mount



3 Foot Hanging Chain Included

- Construction: Solid Brass with Aircraft Quality "O" Rings
- Socket: Stainless Steel (pre-greased)
- Knuckle: Ball and Joint, 360° Orbital Mount
- Mounting: Stratosphere Bracket, Hanging Chain
- Finish Coat: Poly-Thermal Shield
- Weight: 1.1 lbs.
- Wire: 25 feet, 16/2 THW UV Brown
- Level of Light Application: 1, 2 & 3
- Lamp: 20 Watt MR-11, 3,000 hr. Rating
- Maximum Wattage: 20 Watts
- Lifetime Warranty**

### LENSES INCLUDED



MR-11



De-Op Lens  
(Frosted)



Vi-Op Lens  
(Spread)



Ax-Op Lens  
(Linear Spread)



Hex Louver



Blue Lens



WB  
Weathered Brass



NB  
Natural Brass



TT  
Tucson Tan



WH  
White



BK  
Black



VG  
Verde Green

Custom Colors available upon request. Please inquire about lead times.





Model Shown: MERCURY7-B50-20-WB

6.7"



21.5"

4.3"

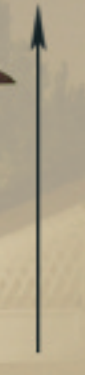

21.5"

50 foot wire lead included

Model Shown: MERCURY4-B50-20-WB

# MERCURY 7 & 4 BRASS AREA/PATH LIGHTS

- Construction: Spun Brass
- Socket: Stainless Steel (pre-greased)
- Height: 3 Adjustable Height Settings
- Finish Coat: Poly-Thermal Shield
- Stake: Brown PVC Stabilizer Stake
- Weight: 1.5 lbs.
- Wire: 50 Feet, 18/2 THW UV Brown
- Level of Light Application: 1 & 2
- Lamp: 20 Watt Astro-Brite, 10,000 hr. Rating
- Maximum Wattage: 20 Watts
- Lifetime Warranty**



Astro-Brite



De-Op Lens (Frosted)



WB Weathered Brass



NB Natural Brass



TT Tucson Tan



WH White



BK Black



VG Verde Green

Custom Colors available upon request. Please inquire about lead times.





## CENTAURUS 4 & 6 BRASS AREA/PATH LIGHTS

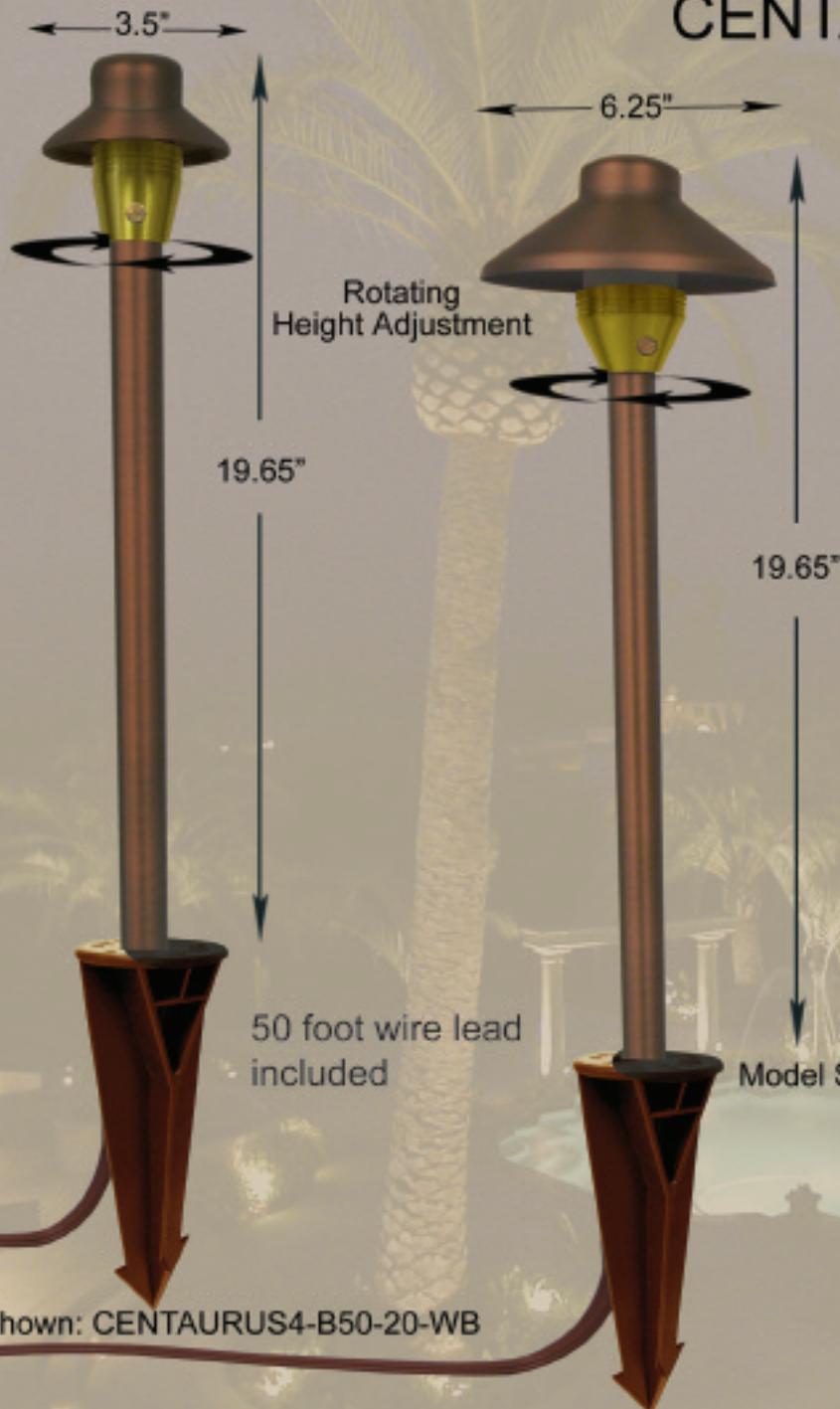

- Construction: Solid Brass Housing With Machined Brass Collar
- Socket: Stainless Steel (pre-greased)
- Height: Rotating Adjustable Height Settings
- Finish Coat: Poly-Thermal Shield
- Stake: Brown PVC Stabilizer Stake
- Weight: 1.65 lbs. (C4) & 2.5 lbs. (C6)
- Wire: 50 Feet, 18/2 THW UV Brown
- Level of Light Application: 1 & 2
- Lamp: 20 Watt Astro-Brite, 10,000 hr. Rating
- Maximum Wattage: 20 Watts
- Lifetime Warranty
- Patent Pending



Custom Colors available upon request. Please inquire about lead times.





# JUPITER & SOLARIS BRASS AREA/PATH LIGHTS

Model Shown: JUPITER-B50-20-WB

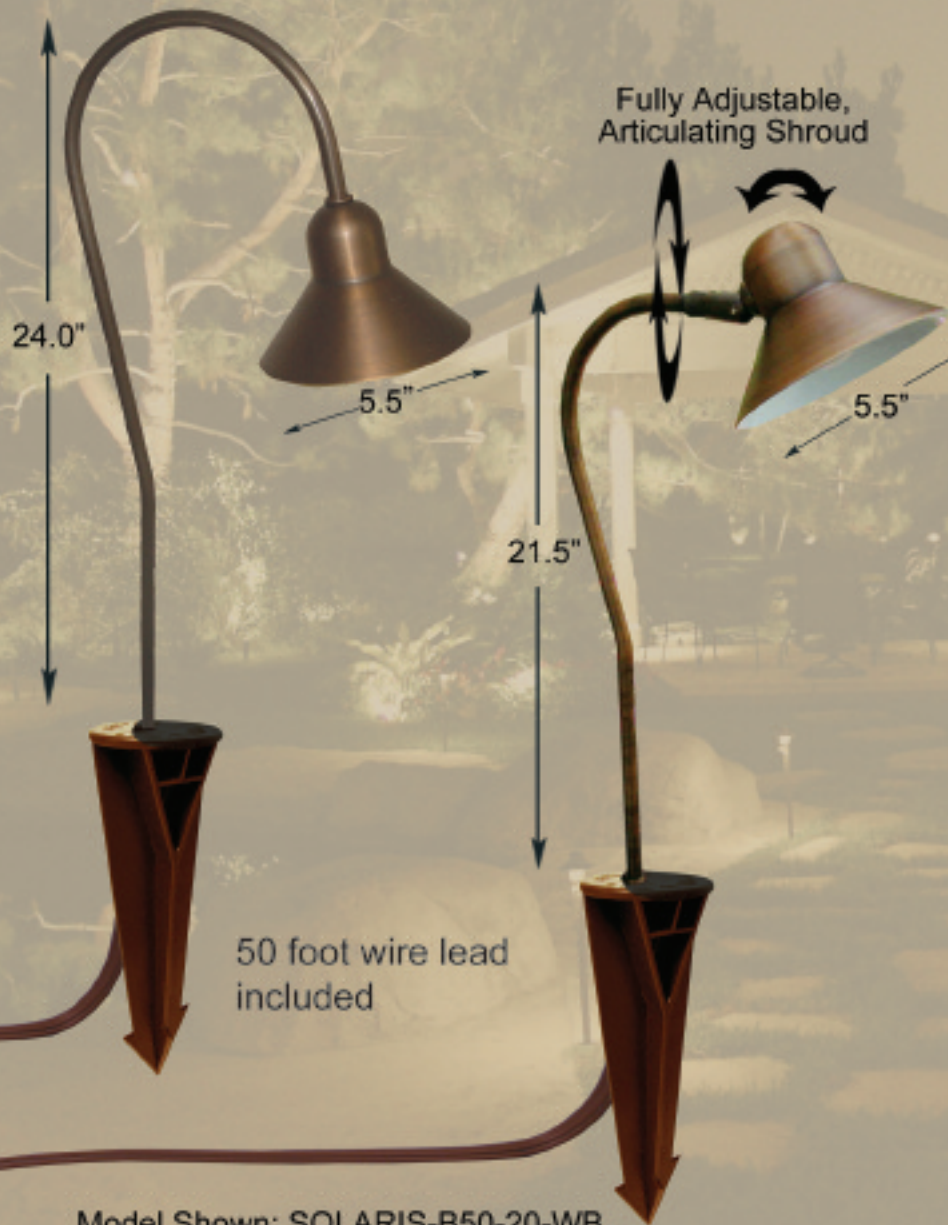

Model Shown: SOLARIS-B50-20-WB

- Construction: Spun Brass
- Shroud: Fully Adjustable, Articulating, 360° rotation (Solaris)
- Knuckle: Solid Machined Brass, Adjustable (Solaris)
- Socket: Stainless Steel (pre-greased)
- Finish Coat: Poly-Thermal Shield
- Stake: Brown PVC Stabilizer Stake
- Weight: 2.0 lbs.
- Wire: 50 Feet, 18/2 THW UV Brown
- Level of Light Application: 1, 2 & 3
- Lamp: 20 Watt Astro-Brite, 10,000 hr. Rating
- Maximum Wattage: 20 Watts
- **Lifetime Warranty**
- **Patent Pending (Solaris)**



Astro-Brite



Clear Lens



De-Op Lens (Frosted)



De-Op Lens (Frosted) (Solaris Only)



WB Weathered Brass



NB Natural Brass



TT Tucson Tan



WH White



BK Black



VG Verde Green

Custom Colors available upon request. Please inquire about lead times.



# CONSTELLATION & SATURN BRASS AREA/PATH LIGHTS



50 foot wire lead included

Model Shown: CONSTELLATION-B50-20-WB

Model Shown: SATURN-B50-20-WB

- Construction: Spun Brass, Machined Natural Brass Collar (Saturn)
- Socket: Stainless Steel (pre-greased)
- Height: 3 Adjustable Height Settings
- Finish Coat: Poly- Thermal Shield
- Stake: Brown PVC Stabilizer Stake
- Weight: Constellation: 1.85 lbs. Saturn: 1.90 lbs.
- Wire: 50 Feet, 18/2 THW UV Brown
- Level of Light Application: 1 & 2
- Lamp: 20 Watt Astro-Brite, 10,000 hr. Rating
- Maximum Wattage: 20 Watts
- **Lifetime Warranty**



Astro-Brite



De-Op Lens (Frosted)



Custom Colors available upon request. Please inquire about lead times.





# VENUS & NEPTUNE BRASS AREA/PATH LIGHTS



- Construction: Spun Brass
- Socket: Stainless Steel (pre-greased)
- Mounting: Integrated Strengthening Support Bushing
- Finish Coat: Poly-Thermal Shield
- Stake: Brown PVC Stabilizer Stake
- Weight: Venus: 1.35 lbs., Neptune: 1.8 lbs.
- Wire: 50 Feet 18/2 THW UV Brown
- Level of Light Application: 1 & 2
- Lamp: 20 Watt Astro-Brite, 10,000 hr. Rating
- Maximum Wattage: 20 Watts
- **Lifetime Warranty**

### LENSES INCLUDED



Astro-Brite



Clear Lens



De-Op Lens (Frosted)



WB Weathered Brass



NB Natural Brass



TT Tucson Tan



WH White



BK Black



VG Verde Green

Custom Colors available upon request. Please inquire about lead times.



# VOYAGER 8 & 5 BRASS STEP LIGHTS

Model Shown: VOYAGER8-B25-20-WB  
 Voyager 8 uses (2) 20 Watt Astro-Brite bulbs (supplied)

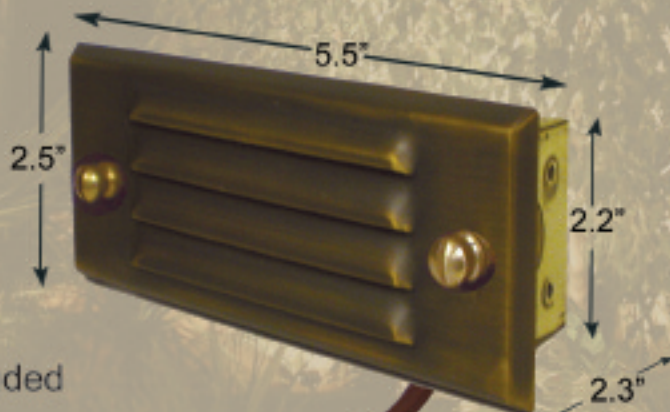
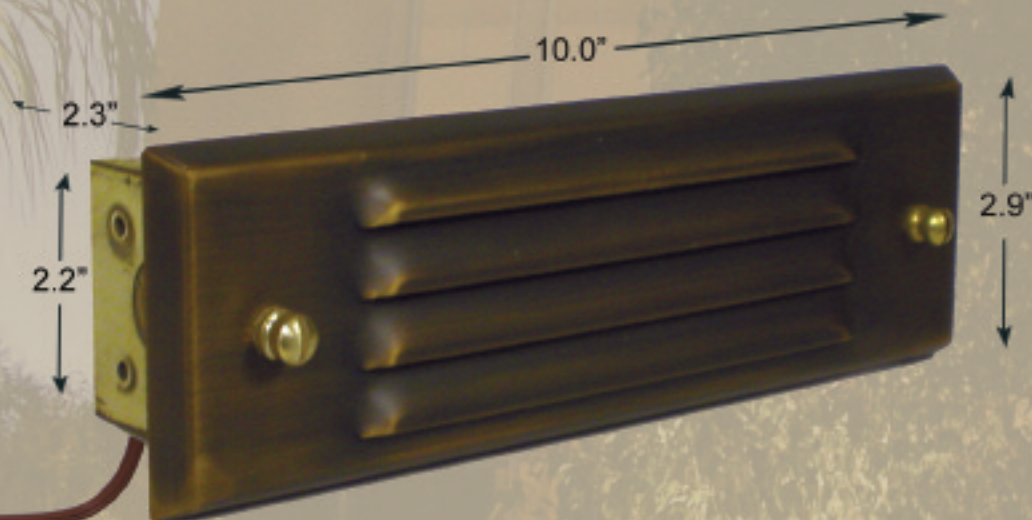

25 foot wire lead included

Model Shown: VOYAGER5-B25-20-WB

- Construction: Brass
- Housing: Natural Brass/Box
- Socket: Stainless Steel (pre-greased)
- Mounting: Flush Mount
- Finish Coat: Poly-Termal Shield
- Weight: Voyager5: .831 lbs. Voyager8: 1.15 lbs.
- Wire: 25 Feet, 16/2 THW UV Brown
- Level of Light Application: 2
- Lamp: 20 Watt Astro-Brite, 10,000 hr. Rating
- Maximum Wattage: 40 Watts (V8) 20 Watts (V5)
- **Lifetime Warranty**

Louver and Wire cover included



Astro-Brite

De-Op Lens Included  
 (Frosted)

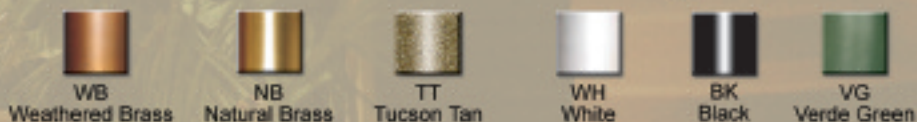

Custom Colors available upon request. Please inquire about lead times.





# GEMINI & VIKING CAST BRASS NICHE LIGHTS

Model shown: GEMINI-B25-20-WB

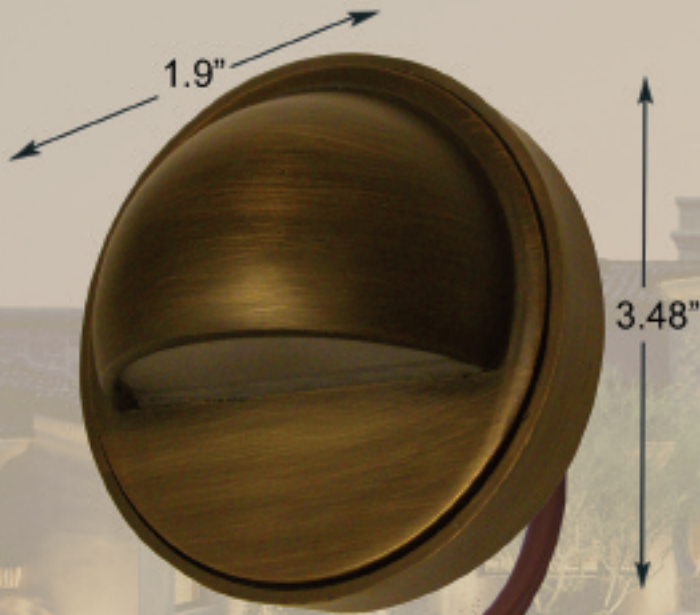

Model shown: VIKING-B25-20-WB

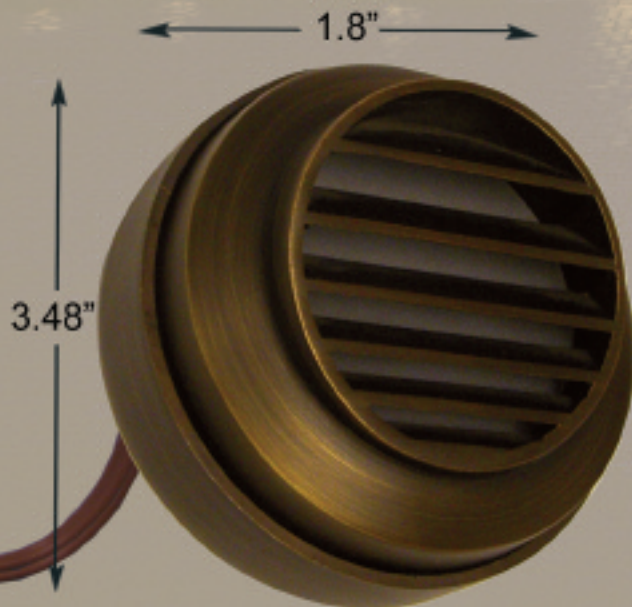

25 foot wire lead included

- Construction: Cast Brass
- Socket: Stainless Steel (pre-greased)
- Mounting: Surface Mount
- Shroud: Lock and Load
- Finish Coat: Poly-Thermal Shield
- Weight: 1.2 lbs.
- Wire: 25 Feet, 16/2 THW UV Brown, White
- Level of Light Application: 1 & 2
- Lamp: 20 Watt Astro-Brite, 10,000 hr. Rating
- Maximum Wattage: 20 Watts
- Lifetime Warranty**



Astro-Brite



De-OP Lens Included  
(Frosted)



WB  
Weathered Brass



NB  
Natural Brass



TT  
Tucson Tan



WH  
White



BK  
Black



VG  
Verde Green

Custom Colors available upon request. Please inquire about lead times.





Model Shown: ORION12-B0-0-WB

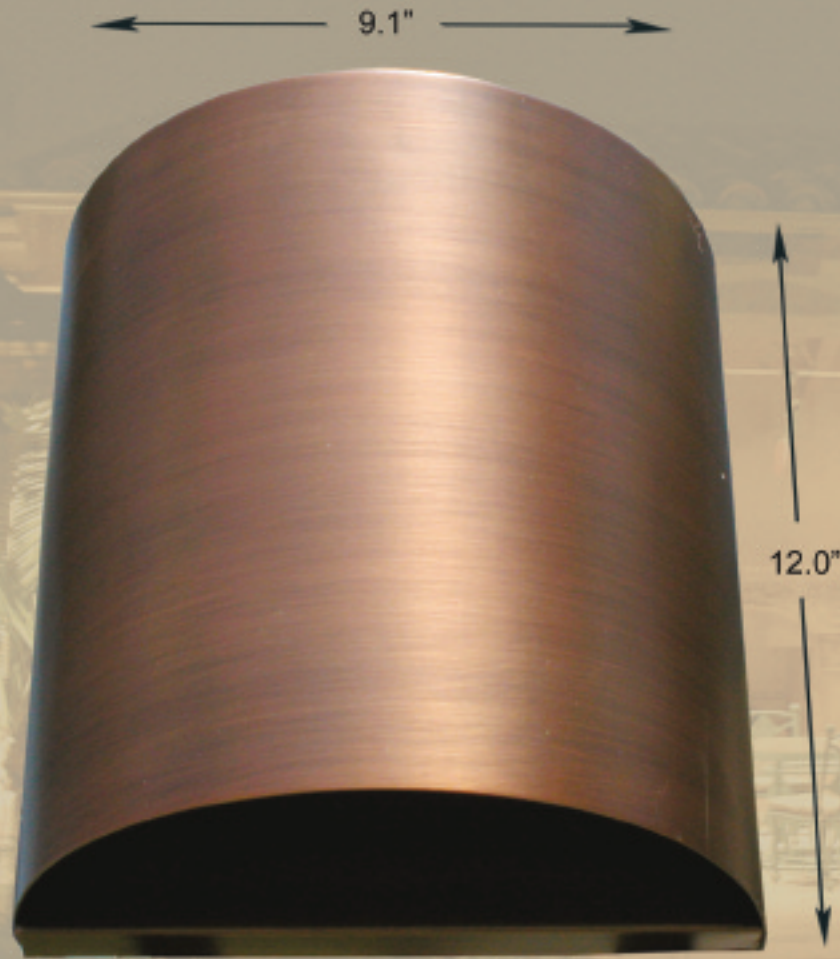

## ORION SERIES BRASS WALL SCONCE

- Construction: Brass
- Socket: Stainless Steel (pre-greased)
- Mounting: Surface Mount
- Finish Coat: Poly-Thermal Shield
- Weight: Orion 4: .750 lbs.  
Orion 6: .850 lbs.  
Orion 9: 1.94 lbs.  
Orion 12: 3.30 lbs.
- Wire: 25 Feet 16/2 THW UV Brown, White (Orion 4 & 6 Only)
- Level of Light Application: 1, 2 & 3
- Lamp: 20 Watt Astro-Brite, 10,000 hr. Rating (Orion 4 & 6 Only)
- Maximum Wattage: 20 Watts (Orion 4 & 6 Only)
- **Lifetime Warranty**

### Notes:

Orion 4 - 12V Includes 1-20W Lamp  
 Orion 6 - 12V Includes 2-20W Lamps Up/Down  
 Orion 9 - 120V No Lamp Supplied  
 Orion 12 - 120V No Lamp Supplied



Astro-Brite  
(Orion 4 & 6 Only)



De-OP Lens Included  
(Frosted)



WB  
Weathered Brass



NB  
Natural Brass



TT  
Tucson Tan



WH  
White



BK  
Black



VG  
Verde Green

Custom Colors available upon request. Please inquire about lead times.



## F225 & F125 WELL LIGHT

Model Shown: F225-BK



25 foot wire lead included

- Construction: ABS Composite (F225)  
PVC Composite (F125)
- Debris Guard: PVC Composite (F125)
- Weight: F225: 1.4 lbs. F125: 1.3lbs.
- Wire: 25 Feet 16/2 THW UV Brown
- Level of Light Application: 1, 2 & 3
- Lamp: 35 Watt PAR 36 WF Halogen, 4,000 hr. Rating
- Maximum Wattage: F125: 35 Watts F225: 50 Watts
- **Lifetime Warranty**

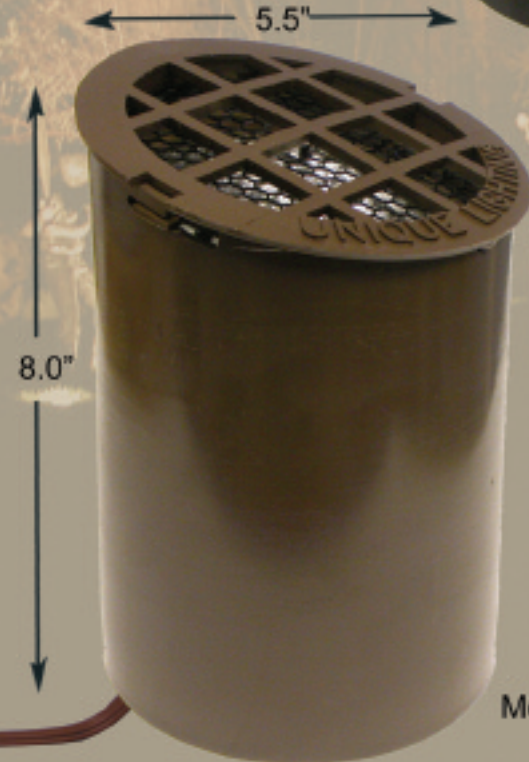

Model Shown: F125-LB

**PATENTED**



Adjustable  
Stainless Steel  
Gimble Ring  
(F225 only)



ABS or Aluminum Grate  
Optional with F225.



Commercial Grade Brass Grate  
Optional with F225.



PAR 36



LB  
Light Brown



Hex  
Louver  
(F125 Only)



BK  
Black



# GUARDIAN & CRUSADER NATURAL COPPER MR-16 BULLET LIGHTS

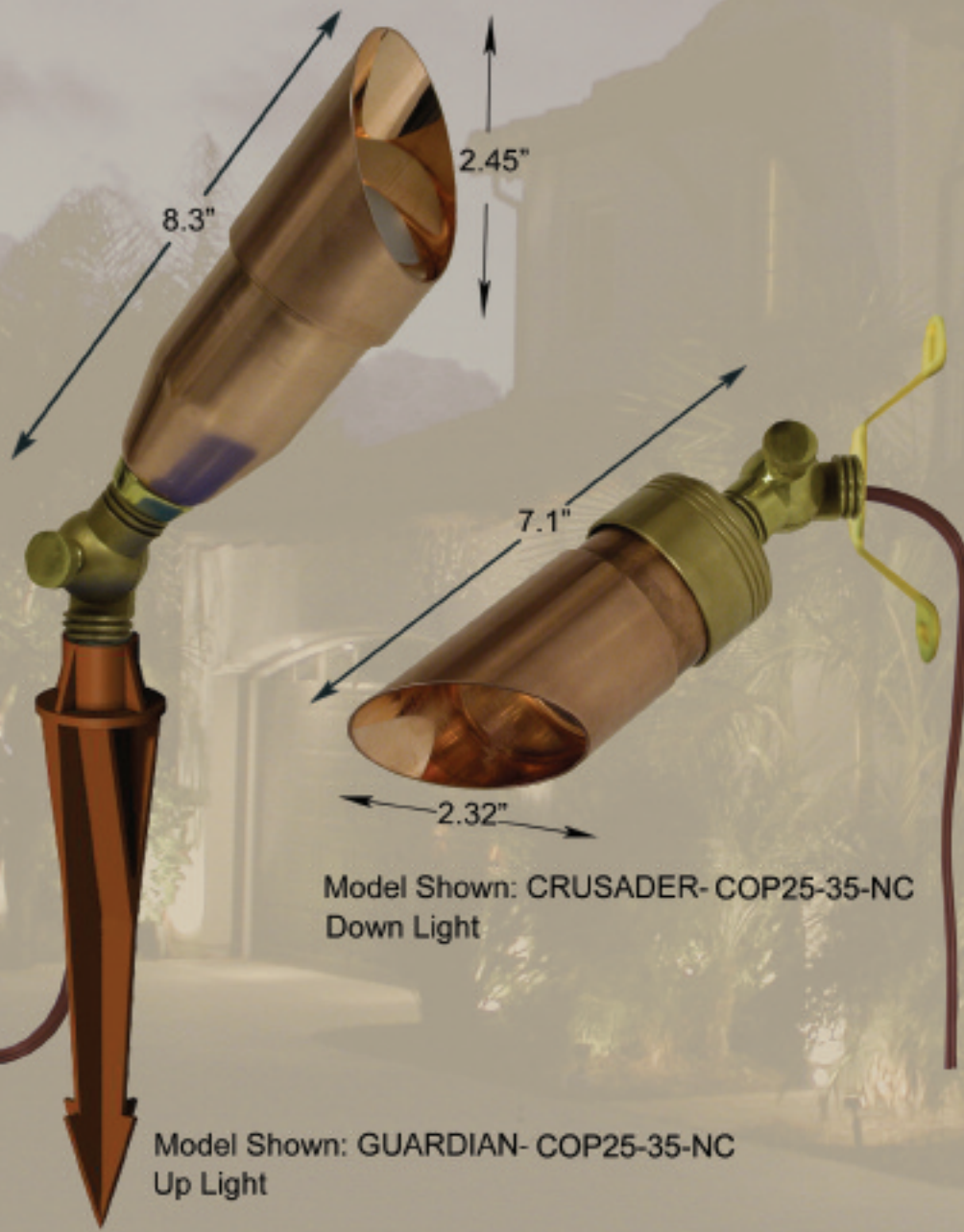

Model Shown: CRUSADER-COP25-35-NC  
Down Light

Model Shown: GUARDIAN-COP25-35-NC  
Up Light

25 foot wire lead included

- Construction: Natural Copper Housing with Cast Brass Base
- Socket: Stainless Steel (pre-greased)
- Mounting: Brass, Mounting Bracket for Crusader (shown)
- Finish Coat: Natural Copper
- Stake: Brown PVC Gravity Stake (Guardian)
- Weight: 1.55 lbs. (Guard.) & 1.4lbs. (Crus.)
- Wire: 25 Feet, 16/2 THW UV Brown
- Level of Light Application: 1, 2 & 3
- Lamp: 35 Watt MR-16 FMW, 4,000 hr. Rating
- Maximum Wattage: 35 Watts
- 15 Year Warranty



MR-16



Clear Convex Lens  
(Guardian Only)



NC

Natural Copper



TT

Tucson Tan



WH

White



BK

Black



VG

Verde Green

Custom colors available upon request. Please inquire about lead times.



# WINDSOR & CANTERBURY NATURAL COPPER WALL WASHER & AREA/PATH LIGHT



Model Shown: WINDSOR-COP25-20-NC

25 foot wire lead included

Model Shown: CANTERBURY-COP25-20-NC

- Construction: Natural Copper Housing, with Machined Brass Knuckle
- Socket: Stainless Steel (pre-greased)
- Mounting: Integrated Strengthening Support Bushing
- Shroud: Fully Adjustable, Articulating, 360° Rotation
- Finish Coat: Natural Copper
- Stake: Brown PVC Stabilizer Stake
- Weight: Wind.: 1.65 lbs. Cant.: 2.15 lbs.
- Wire: 25 Feet, 18/2 THW UV Brown
- Level of Light Application: 1 & 2
- Lamp: 20 Watt Astro-Brite, 10,000 hr. Rating
- Maximum Wattage: 20 Watts
- 15 Year Warranty
- Patent Pending



Astro-Brite



De-Op Lens (Frosted)



NC

Natural Copper



TT

Tucson Tan



WH

White



BK

Black



VG

Verde Green

Custom colors available upon request. Please inquire about lead times.





Model Shown: Illuminator6-COP25-20-NC

## ILLUMINATOR 6 & 4 NATURAL COPPER AREA/PATH LIGHTS



- Construction: Natural Copper Housing with Brass Collar
- Socket: Stainless Steel (pre-greased)
- Height: Rotating Height Adjustment
- Finish Coat: Natural Copper
- Stake: Brown PVC Molded Stabilizer Stake
- Weight: 2.5 lbs. (I6) & 1.65 lbs. (I4)
- Wire: 25 Feet, 18/2 THW UV Brown
- Level of Light Application: 1 & 2
- Lamp: 20 Watt Astro-Brite, 10,000 hr. Rating
- Maximum Wattage: 20 Watts
- 15 Year Warranty
- Patent Pending

Model Shown: Illuminator4-COP25-20-NC



Astro-Brite



De-Op Lens (Frosted)



NC

Natural Copper



TT

Tucson Tan



WH

White



BK

Black



VG

Verde Green

Custom colors available upon request. Please inquire about lead times.





# CAMELOT NATURAL COPPER AREA/PATH LIGHT

8.0"

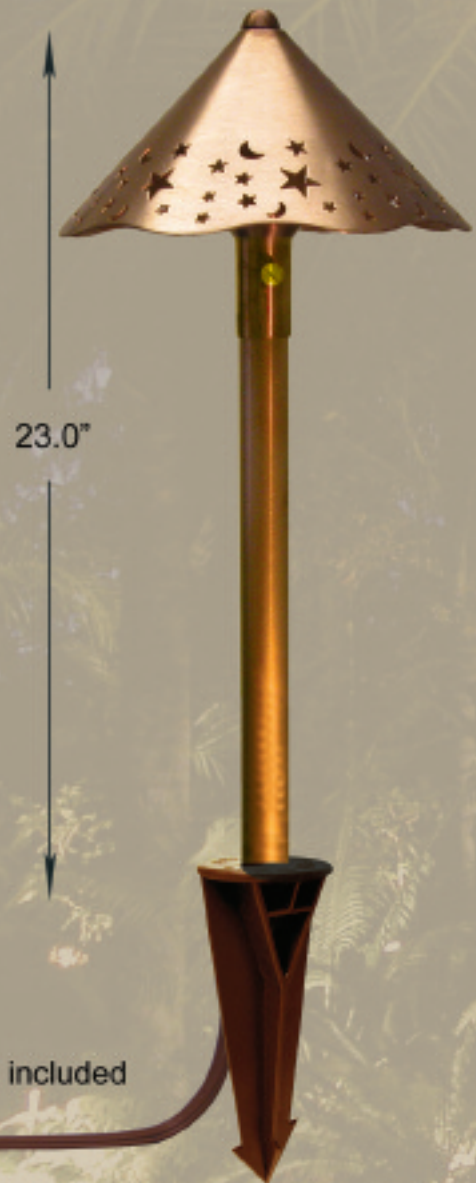

23.0"

25 foot wire lead included

Model Shown: CAMELOT-COP25-20-NC

- Construction: Natural Copper
- Socket: Stainless Steel (pre-greased)
- Height: 3 Adjustable Height Settings
- Finish Coat: Natural Copper
- Stake: Brown PVC Molded Stabilizer Stake
- Weight: 1.85 lbs.
- Wire: 25 Feet, 18/2 THW UV Brown
- Level of Light Application: 1 & 2
- Lamp: 20 Watt Astro-Brite, 10,000 hr. Rating
- Maximum Wattage: 20 Watts
- 15 Year Warranty



Astro-Brite



De-Op Lens (Frosted)



NC Natural Copper



TT Tucson Tan



WH White



BK Black



VG Verde Green

Custom colors available upon request. Please inquire about lead times.



# NAUTILUS MACHINED STAINLESS STEEL UNDERWATER LIGHT

Model Shown: NAUTILUS-S50-35-SS

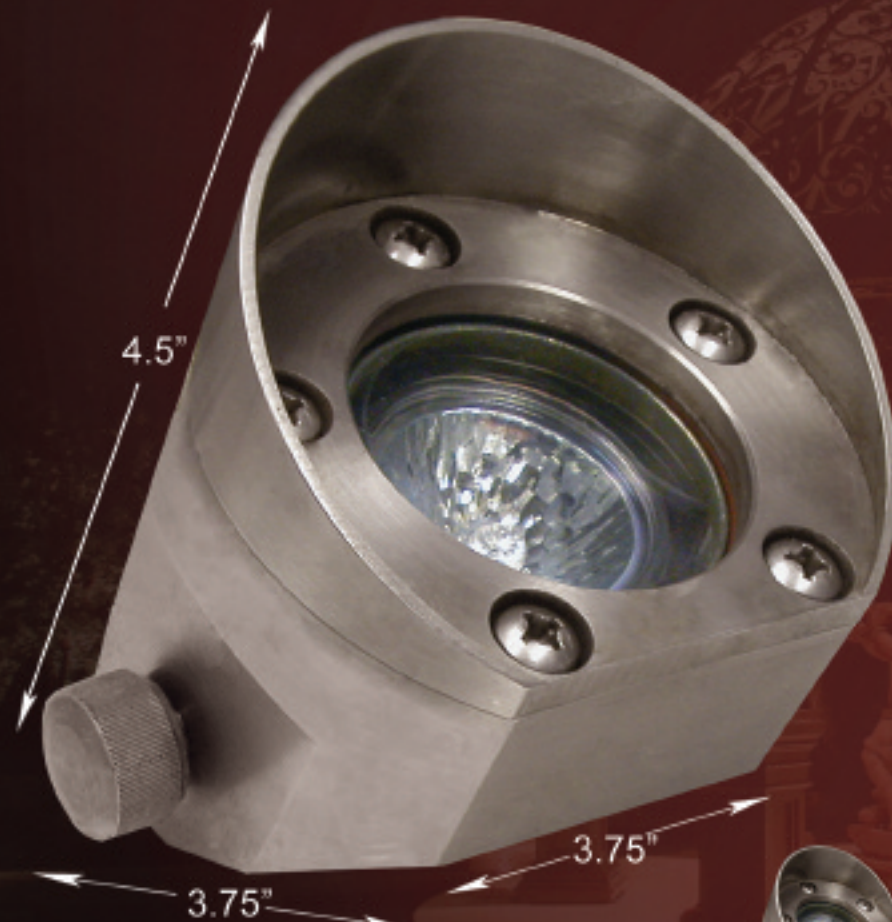

- Construction: Machined Stainless Steel (318) with Aircraft Quality Double Silicon "O" Rings
- Socket: Stainless Steel Spring (pre-greased)
- Knuckle: Large Locking Thumb Screw
- Finish Coat: Stainless Steel, Non-Toxic To Fish
- Mounting: 10" Stainless Steel 14 Guage Base
- Shroud: Stainless Steel
- Weight: 9.2 lbs.
- Wire: 50 Feet, 16/2 THW UV Brown
- Level of Light Application: 1, 2 & 3
- Lamp: 35 Watt MR-16 FMW, 4,000 hr. Rating
- Maximum Wattage: 50 Watts
- **Lifetime Warranty**
- **Patent Pending**

Safety tested in depths up to eight feet.

Pre-set angles for positioning: 45°  
30°  
90°

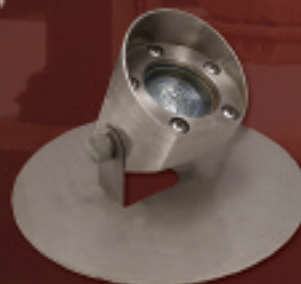

Shown with base plate



MR-16



De-Op  
Lens  
(Frosted)



Clear  
Lens



Domed  
De-Op



Lens  
Retainer



SS  
Stainless Steel



# AUGUSTA PUTTING GREEN LIGHT

Model Shown: AUGUSTA-C50-20-WH



- Construction, Putting Green Light Enclosure: UV Stabilized Composite
- Light Includes: Pin, Cup Housing & Fixture
- Fixture Construction: Cast Brass
- Socket: Stainless Steel (pre-greased)
- Finish Coat: Poly-Thermal Shield
- Weight: 3.05 lbs.
- Wire: 50 Feet, 16/2 THW UV Brown
- Level of Light Application: 1, 2 & 3
- Lamp: 20 Watt MR-16 BAB, 4,000 hr. Rating
- Maximum Wattage: 20 Watts
- Lifetime Warranty
- Patent Pending

UV stabilized composite cup housing surrounds the removable pin. Light is cast upward through housing giving off the perfect illumination for every putt.



MR-16



WH  
White

\* Custom Kits Available



# ENDEAVOUR BRASS BARBECUE/AREA LIGHT

Model Shown: ENDEAVOUR-B50-35-WB

14



14

Light up your whole cooking area, not just the grill. The Endeavour will enhance your whole entertaining area while illuminating your cooking surface, truly an Industry First!



- Construction: Solid Brass Housing With Machined Brass Collar
- Socket: Stainless Steel (pre-greased)
- Height: Rotating Adjustment Settings
- Finish Coat: Poly-Thermal Shield
- Weight: 6.0 lbs.
- Wire: 50 Feet, 18/2 THW UV Brown
- Level of Light Application: 1 & 2
- Lamp: 35 Watt Astro-Brite, 5,000 hr. Rating
- Maximum Wattage: 35 Watts
- **Lifetime Warranty**



Astro-Brite



De-Op Lens  
(Frosted)



WB  
Weathered Brass



NB  
Natural Brass



TT  
Tucson Tan



WH  
White



EK  
Black



VG  
Verde Green

Custom colors available upon request. Please inquire about lead times.



# Odyssey Transformer Series

## The Powerstar



*Signature Series*

Removable, hinged door

Each circuit is  
independantly fused

Snap in photocell ready

Independant lugs for each homerun

### Features and Benefits:

- Industry first individually replaceable fuses on each run.
- Brass can with weathered brass finish
- Replaceable secondary circuit fusing
- Removable photocell
- Primary fuse protection
- Digital timer ready/analog timer ready
- Sequencer ready
- Hinged, lockable door
- 110v wiring compartment
- High temperature rating

### PART NUMBER

### WATTS

### AVAILABLE TAPS

PS500WB	500 Watt	12, 13, 14, 15, 16 and 17 Volts
PS500WBPC	500 Watt	12, 13, 14, 15, 16 and 17 Volts
PS500WBT	500 Watt	12, 13, 14, 15, 16 and 17 Volts
PS500WBTPC	500 Watt	12, 13, 14, 15, 16 and 17 Volts
PS1120WB	1120 Watt	12, 13, 14, 15, 16, 18, 20 and 22 Volts
PS1120WBPC	1120 Watt	12, 13, 14, 15, 16, 18, 20 and 22 Volts
PS1120WBT	1120 Watt	12, 13, 14, 15, 16, 18, 20 and 22 Volts
PS1120WBTPC	1120 Watt	12, 13, 14, 15, 16, 18, 20 and 22 Volts

### Dimensions:

15.25" high x 8.3" wide x 6.2" deep      Sizes: 1120, 840, 600, 500, 360

\* Please call for availability



## Inverted Transformer Series

### The I-Force

The only upright transformer series in the industry

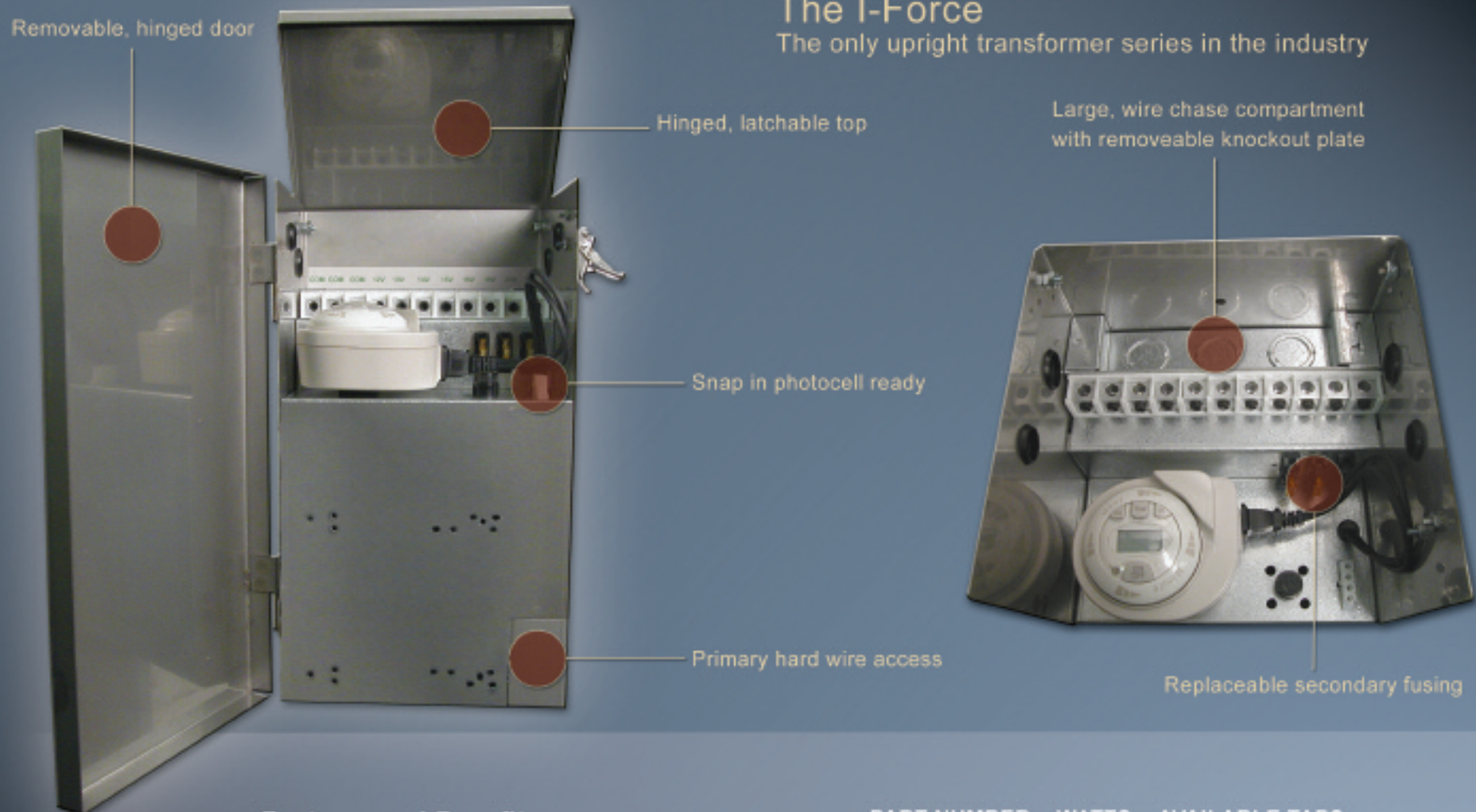

#### Features and Benefits:

- |                                       |   |
|---------------------------------------|---|
| Comfortable to install                | Hinged door   |
| Spacious lug for multiple connections | Lockable door   |
| Replaceable secondary circuit fusing  | 110v wiring compartment   |
| Removable photocell                   | Rain tight Stainless Steel  |
| Primary fuse protection               | Smart mounting bracket  |
| Digital/analog timer ready            | High temperature rating   |
| Sequencer ready                       | Internal storage compartment holds-<br>spare fuses and allen wrench |
| Large wire chase compartment          |   |

PART NUMBER	WATTS	AVAILABLE TAPS
IF360	360 Watt	12, 13, 14 and 15 Volts
IF500	500 Watt	12, 13, 14, 15, 16 and 17 Volts
IF600	600 Watt	12, 13, 14, 15, 16 and 17 Volts
IF840	840 Watt	12, 13, 14, 15, 16, 18, 19 and 20 Volts

#### Dimensions:

13.5" high x 7.5" wide x 8" deep

\* Please call for availability



LIFETIME WARRANTY ON ALL TRANSFORMERS  
INDUSTRY LEADER FOR OVER 10 YEARS



**Direct Burial**



**Multimatic Power Transformer**

- Stainless Steel



**Inverted Transformer**

- Secondary fusing included
- Inverted for easy access

## DIRECT BURIAL TRANSFORMERS

PART NUMBER	WATTS	AVAILABLE TAPS
360DB	360 Watt	12, 13, 14 and 15 Volts
500DB	500 Watt	12, 13, 14, 15, 16 and 17 Volts
840DB	840 Watt	12, 13, 14, 15, 16, 18 and 20 Volts
1120DB	1120 Watt	12, 13, 14, 15, 16, 18, 20 and 22 Volts
300-24-DB	300 Watt	24, 25 and 26 Volts
500-24-DB	500 Watt	24, 25, 26, 27 and 28 Volts

## AQUATIC TRANSFORMERS (pool, pond & water feature series)

PART NUMBER	WATTS	AVAILABLE TAPS
360SSPST	360 Watt	12, 13, 14 and 15 Volts
360SSPSTPC	360 Watt	12, 13, 14 and 15 Volts
360SSPSTT	360 Watt	12, 13, 14 and 15 Volts
360SSPSTTPC	360 Watt	12, 13, 14 and 15 Volts
840SSPST	840 Watt	12, 13, 14, 15, 16, 18 and 20 Volts
840SSPSTPC	840 Watt	12, 13, 14, 15, 16, 18 and 20 Volts
840SSPSTT	840 Watt	12, 13, 14, 15, 16, 18 and 20 Volts
840SSPSTTPC	840 Watt	12, 13, 14, 15, 16, 18 and 20 Volts

## I-FORCE INVERTED TRANSFORMERS

PART NUMBER	WATTS	AVAILABLE TAPS
IF360	360 Watt	12, 13, 14 and 15 Volts
IF500	500 Watt	12, 13, 14, 15, 16 and 17 Volts
IF600	600 Watt	12, 13, 14, 15, 16 and 17 Volts
IF840	840 Watt	12, 13, 14, 15, 16, 18, 19 and 20 Volts

## POWERSTAR ODYSSEY TRANSFORMERS

PART NUMBER	WATTS	AVAILABLE TAPS
PS500WB	500 Watt	12, 13, 14, 15, 16 and 17 Volts
PS500WBPC	500 Watt	12, 13, 14, 15, 16 and 17 Volts
PS500WBT	500 Watt	12, 13, 14, 15, 16 and 17 Volts
PS500WBTPC	500 Watt	12, 13, 14, 15, 16 and 17 Volts
PS1120WB	1120 Watt	12, 13, 14, 15, 16, 18, 20 and 22 Volts
PS1120WBPC	1120 Watt	12, 13, 14, 15, 16, 18, 20 and 22 Volts
PS1120WBT	1120 Watt	12, 13, 14, 15, 16, 18, 20 and 22 Volts
PS1120WBTPC	1120 Watt	12, 13, 14, 15, 16, 18, 20 and 22 Volts

## MULTIMATIC POWER TRANSFORMERS

PART #	WATTS	TAPS AVAILABLE
300SS-SL	300 Watt	12 and 13 Volts
300SSPC-SL	300 Watt	12 and 13 Volts
300SST-SL	300 Watt	12 and 13 Volts
300SSTPC-SL	300 Watt	12 and 13 Volts
360SS-SL	360 Watt	12, 13, 14 and 15 Volts
360SSPC-SL	360 Watt	12, 13, 14 and 15 Volts
360SST-SL	360 Watt	12, 13, 14 and 15 Volts
360SSTPC-SL	360 Watt	12, 13, 14 and 15 Volts
500SS-SL	500 Watt	12, 13, 14, 15, 16 and 17 Volts
500SSPC-SL	500 Watt	12, 13, 14, 15, 16 and 17 Volts
500SST-SL	500 Watt	12, 13, 14, 15, 16 and 17 Volts
500SSTPC-SL	500 Watt	12, 13, 14, 15, 16 and 17 Volts
600SS-SL	600 Watt	12, 13, 14, 15, 16 and 17 Volts
600SSPC-SL	600 Watt	12, 13, 14, 15, 16 and 17 Volts
600SST-SL	600 Watt	12, 13, 14, 15, 16 and 17 Volts
600SSTPC-SL	600 Watt	12, 13, 14, 15, 16 and 17 Volts
840SS-SL	840 Watt	12, 13, 14, 15, 16, 18, and 20 Volts
840SSPC-SL	840 Watt	12, 13, 14, 15, 16, 18, and 20 Volts
840SST-SL	840 Watt	12, 13, 14, 15, 16, 18, and 20 Volts
840SSTPC-SL	840 Watt	12, 13, 14, 15, 16, 18, and 20 Volts
1120SS-SL	1120 Watt	12, 13, 14, 15, 16, 18, 20 and 22 Volts
1120SSPC-SL	1120 Watt	12, 13, 14, 15, 16, 18, 20 and 22 Volts
1120SST-SL	1120 Watt	12, 13, 14, 15, 16, 18, 20 and 22 Volts
1120SSTPC-SL	1120 Watt	12, 13, 14, 15, 16, 18, 20 and 22 Volts

Other Transformers Available Upon Request

SS = Stainless Steel

T = Timer

PC = Photo Cell

SL = Secondary Lugs

WB = Weathered Brass

\* Wire Options Available

\* Call for availability





In addition to having the highest quality parts, you need to have an integrated system to create a lighting portrait. Inconsistent light output between fixtures is known to ruin most lighting portraits. For this reason Unique developed the Equalizer™ Hub Wiring System. Using the Multimatic Power Transformer, the Equalizer™ Hub Wiring System, and our top of the line fixtures, Unique has created the only system that produces even lighting output at every fixture. Unique Lighting fixtures come with a 25-foot wire lead that taps into the Equalizer™ Hub creating a simple, and maintenance-free lighting system!



FHUB

The Equalizer™ wiring system has proven to be a breakthrough for landscape lighting. It allows you to receive equal voltage to every lamp every time! The Equalizer™ Hub ensures proper voltage distribution and can be used with one or more fixtures. It ensures no connections in the the ground and uses only two connections per wire run. The Equalizer™ Hub includes two barrel lugs with lithium greased caps . The black housing blends discreetly for above or below ground installation.

The Satellite™ Hub is the ultimate In-Line fuse protected wiring system. It allows you to size the fuse according to load or wire size. Unique includes a replaceable 20 amp fuse at the point of connection to make troubleshooting accessible, convenient and fast. The Satellite™ Hub ensures proper voltage distribution and can be used with one or more fixtures. The Satellite™ Hub includes three barrel lugs with lithium greased caps and a In-Line 20 amp fuse. The dark brown housing blends discreetly for above or below ground installation.



SHUB





35 Watt MR-16



Unique Exclusive 35 Watt Astro-Brite



Unique Exclusive 20 Watt Astro-Brite



PAR 36

## LONGEST LAMP LIFE AVAILABLE...

Two key items to consider before making your landscape lighting decision are lamp life and color of light emitted from the bulb. Being the innovator in the field, Unique uses lamps that produce the best illumination while lasting the longest period of time. All of Unique's Odyssey fixtures come with a high quality Halogen or Astro-Brite lamp that will last between 4,000 to 20,000 hours, giving you years of trouble-free operation. Most importantly, the lamps produce beautiful white light that preserves the natural color and aesthetics of your landscape and property.

## EXCLUSIVE TO UNIQUE...

Astro-Brite lamps give adequate light levels with minimum energy usage, ensuring Level 1 light output onto hard surfaces. With it's up to 20,000 hour rating, the Astro-brite will out-last any other lamp. In addition, unlike halogen, the Astro-Brite is unaffected by the oils on your fingers. All bi-pin sockets are stainless steel to last a lifetime, along with being factory greased to prevent corrosion and pitting. It also incorporates an extra heavy-duty ceramic socket rated for 25 amps.

All components are replaceable.

Technical support at 1.800.955.4831

Lights that last a LIFETIME.





# Accessories



Digital Timer



"The Sequencer"



Snap in Photocell



Brass Lugnuts



Fuses



Amp Probe & Volt Meter



Commercial Grade  
Brass Grate



ABS Grate



Eclipse Glare Shield



Stabilizer Stake  
Gravity Stake



Lenses

## UNIQUE LIGHTING SYSTEMS

JBOX-B-WB Solid Brass J-Box, weathered brass finish  
 JBOX-B-WH Solid Brass J-Box, white finish  
 APOLLODEBRIS Apollo Debris Guard with Clear Lens  
 APOLLOOPTWB Apollo Eclipse Glare Shield  
 APDG-FRS De-Op Lens for Apollo Debris Guard  
 APDG-SPD Vi-Op Lens for Apollo Debris Guard  
 APDG-LNR Ax-Op Lens for Apollo Debris Guard  
 APDG-HNY Honeycomb Glare Lens for Apollo Debris Guard  
 APDG-BLUE Blue Lens for Apollo Debris Guard  
 BB-BLUE Blue Lens for Big Bang (Diameter 4.312")  
 MR16BLUE Blue Lens for MR 16 Lamp  
 MR11BLUE Blue Lens for MR 11 Lamp  
 16 CLIP Lens Retainer Clip for MR 16 Lamp  
 11 CLIP Lens Retainer Clip for MR 11 Lamp  
 GRAVITYSTAKE Gravity Stake (Color Brown)  
 STABILIZERST Stabilizer Stake (Color Brown)  
 NOVAOPTIONWB Nova Eclipse Glare Shield  
 F110-BK Extender Can for stacking of F100 and F125's  
 F110-LB Extender Can for stacking of F100 and F125's  
 F225GRATE ABS Composite Grate for F225  
 F225CLEAR Clear Lens for F225 Grate  
 F225FROST De-Op Lens for F225 Grate  
 F225HEX Hex Louver for F225 Grate  
 F225LINEAR Ax-Op Lens for F225 Grate  
 F225SPREAD Vi-Op Lens for F225 Grate  
 115ALUM Aluminium Grate, Powder-coated for F100 and F125's  
 RG115-BK F100 and F125 Replacement Grate, black  
 RG115-LB F100 and F125 Replacement Grate, brown  
 RR120-BK F100 and F125 Replacement Rubber Gimble Ring, black  
 RR120-LB F100 and F125 Replacement Rubber Gimble Ring, brown



Super Demo Kit



Resource Manuals

4D-OP-Kit 1 Eclipse Glare Device and 3 Optical Lenses: Ax-Op, De-Op and Vi-Op  
 OX Oxguard Connection Grease 8 oz. Tube  
 LUG-NUT (30-322) Solid Brass threaded lug nut with black wire nut.  
 20 Amp Inline Fuse  
 TOOLKIT Tool Kit  
 Volt Meter  
 Amp Probe  
 SUPERDEMOKIT Super Demo Kit, 1-840 Transformer, 12 Well Lights,  
 4 Odyssey Fixtures, Tape, Flags, Lamp Kit in a Rolling Case.  
 Wired with Quick Connects for ease of use.  
 12DEMOCONN 2 Each Black and White Quick Connects with Contacts for #12 Wire  
 16DEMOCONN 2 Each Black and White Quick Connects with Contacts for #16 Wire  
 Landscape Lighting Resource Manual - Workbook Bound  
 Landscape Lighting Resource Manual - Hard Bound

T Timer  
 PC Photocell  
 F4 4 Amp Fuse  
 F5 5 Amp Fuse  
 F6 6 Amp Fuse  
 F8 8 Amp Fuse  
 F10 10 Amp Fuse  
 F10-AUTOPACK 10 Amp Secondary Auto Spade Fuse Pack  
 F15-AUTOPACK 15 Amp Secondary Auto Spade Fuse Pack  
 F20-AUTOPACK 20 Amp Secondary Auto Spade Fuse Pack  
 RM-10-PC 10' Remote Photocell Kit (includes wire, 2 connectors and bell box)  
 RM-25-PC 25' Remote Photocell Kit (includes wire, 2 connectors and bell box)  
 SNPC Snap-In Photocell, SNPC-R Remote 15 foot Snap-In Photocell  
 DT-1 Digital Timer  
 INLINE Inline Fuse Holder with 20 Amp Fuse  
 SEQUENCER The "All On" module





Architects

*&  
Designers*

Unique Lighting is dedicated to supporting Architects and Designers. With our Power Management System and superior lighting components, performance and versatility are guaranteed.

Our Consumer Buyer Protection Plan guarantees our system for a lifetime and ensures you that we stand behind our products.

Along with our Protection Plan, Unique Lighting provides technical assistance, design help and contractor referrals to ensure that your lighting portrait remains beautiful for a lifetime.

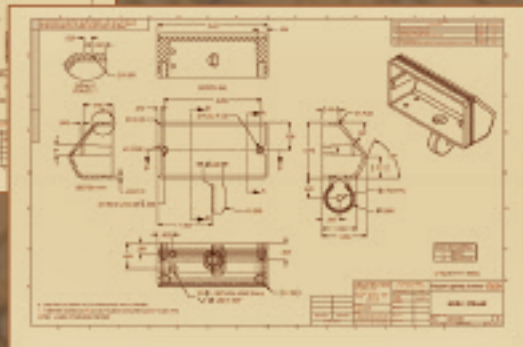
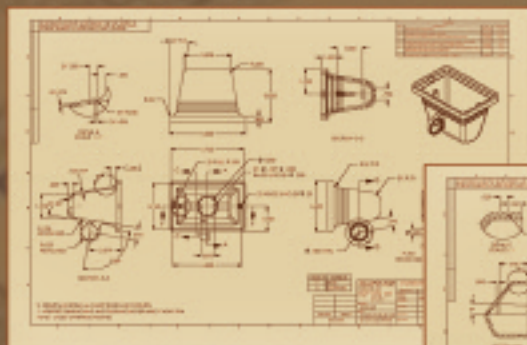







## The Innovators of the Low Voltage Lighting Industry

- First to offer an Inverted transformer series
- First Multi-Tap 12-22 volt transformer
- First Equalizer Hub System
- First solid brass fixture to offer a Lifetime Warranty
- First to offer a 15 Year Warranty on copper fixtures
- First to offer 25 & 50 foot wire leads on fixtures
- First to offer lenses with each fixture
- First to offer encapsulated direct burial transformer
- First to offer a stainless steel transformer can
- First to offer a solid brass transformer can
- First to offer uniform fixture pricing
- First to offer a 2-day, in-the-field lighting training course (Unique University)
- First to offer a Lifetime Warranty on the entire system

### SUPERIOR MATERIALS...

In order to provide you with a lifetime warranty on our fixtures, Unique uses the best materials available to withstand rust and corrosion. However, please be aware that all aluminum products will deteriorate over time from rust and corrosion due to the metal's properties. This is why we offer you Odyssey fixtures that are made from solid brass and Copper Knights fixtures made from solid copper with stainless steel lamp sockets. The solid brass construction can withstand the various elements associated with outdoor landscapes and it will last! Remember, it is not only how beautiful the finish is on the outside, but also what is underneath that counts. At Unique, lighting products are viewed as a lifetime investment!

### APPROVED POWER SOURCES...

ALL of Unique's transformers have multiple ETL Listings that meet all UL Standards that make it the safest and most versatile power supply available. Whether you need to power-up fixtures near water, in a structure, in the landscape or on the home, Unique's Multimatic Power Transformers are approved for all outdoor low voltage lighting applications.

Cover Credits: Front- John Pfeiffer Electric • Back- Randy Smith, 2004 Unique Lighting Systems Golden Pallet Award winner

©Copyright 2005, Unique Lighting Systems, Escondido, CA 92029

All rights reserved. Images and text may not be reproduced in any form without the expressed consent of Unique Lighting Systems.



Innovative Lighting Solutions That Last A Lifetime

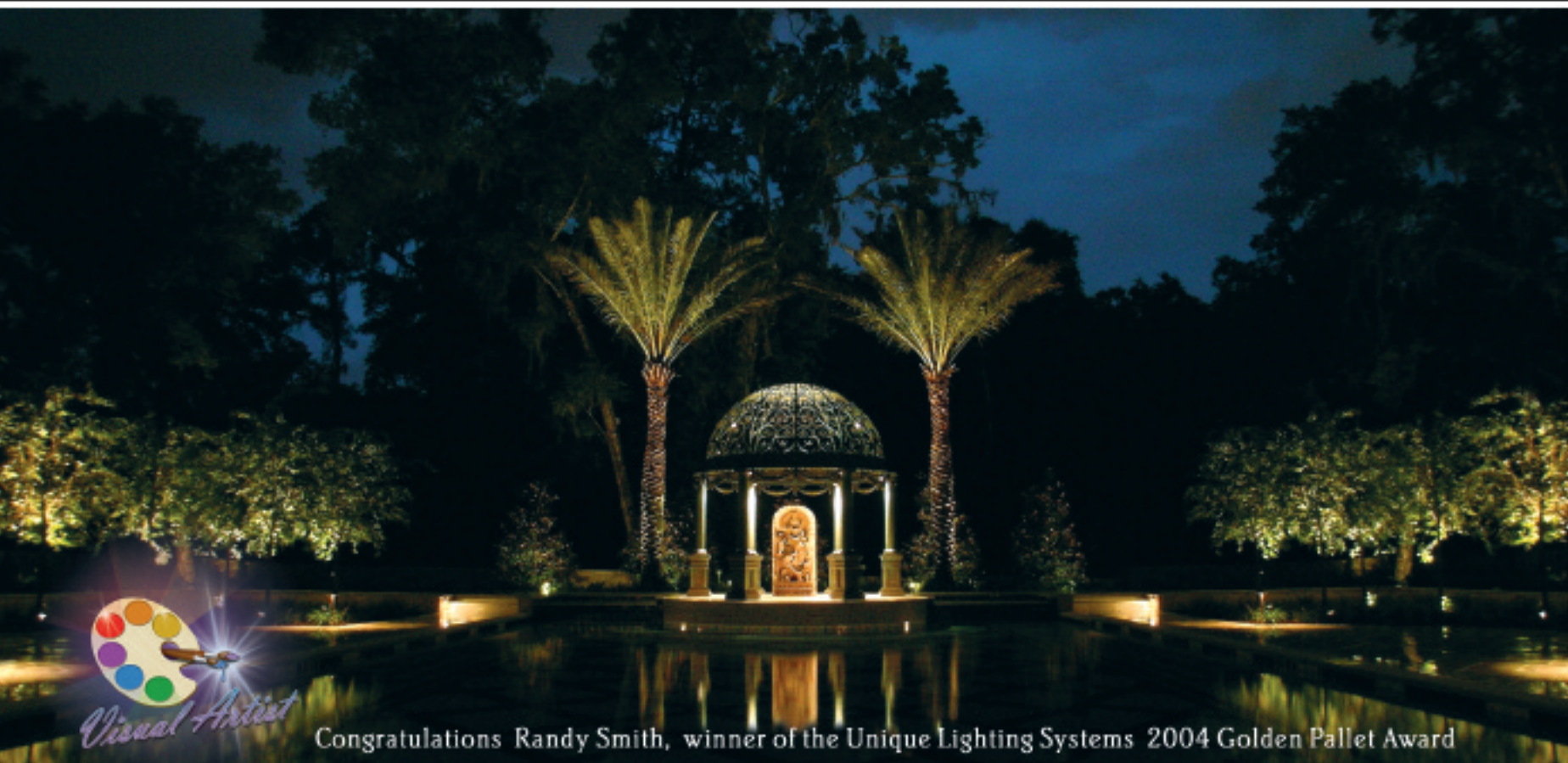

Congratulations Randy Smith, winner of the Unique Lighting Systems 2004 Golden Pallet Award



1240 Simpson Way Escondido, CA 92029 • Phone 800.955.4831 • Fax 760.740.0977 • [www.uniquelighting.com](http://www.uniquelighting.com)



UNIQUE  
LIGHTING SYSTEMS

... Performing Nightly

2  
0  
0  
5